

MOS FIELD EFFECT TRANSISTOR
2SK2137

SWITCHING
N-CANNEL POWER MOS FET
INDUSTRIAL USE

DESCRIPTION

The 2SK2137 is N-Channel MOS Field Effect Transistor designed for high voltage switching applications.

FEATURES

- Low On-Resistance
2SK2137: $R_{DS(on)} = 2.4 \Omega$ ($V_{GS} = 10 V$, $I_D = 2.0 A$)
- Low C_{iss} $C_{iss} = 550 pF$ TYP.
- High Avalanche Capability Ratings
- Isolate TO-220 Package

ABSOLUTE MAXIMUM RATINGS ($T_A = 25 \text{ }^\circ\text{C}$)

Drain to Source Voltage	V_{DS}	600	V
Gate to Source Voltage	V_{GS}	± 30	V
Drain Current (DC)	$I_D(DC)$	± 4.0	A
Drain Current (pulse)*	$I_D(pulse)$	± 16	A
Total Power Dissipation ($T_c = 25 \text{ }^\circ\text{C}$)	P_{T1}	30	W
Total Power Dissipation ($T_A = 25 \text{ }^\circ\text{C}$)	P_{T2}	2.0	W
Channel Temperature	T_{ch}	150	$^\circ\text{C}$
Storage Temperature	T_{stg}	-55 to +150	$^\circ\text{C}$
Single Avalanche Current**	I_{AS}	4.0	A
Single Avalanche Energy**	E_{AS}	5.3	mJ

* $PW \leq 10 \mu s$, Duty Cycle $\leq 1 \%$

** Starting $T_{ch} = 25 \text{ }^\circ\text{C}$, $R_G = 25 \Omega$, $V_{GS} = 20 V \rightarrow 0$

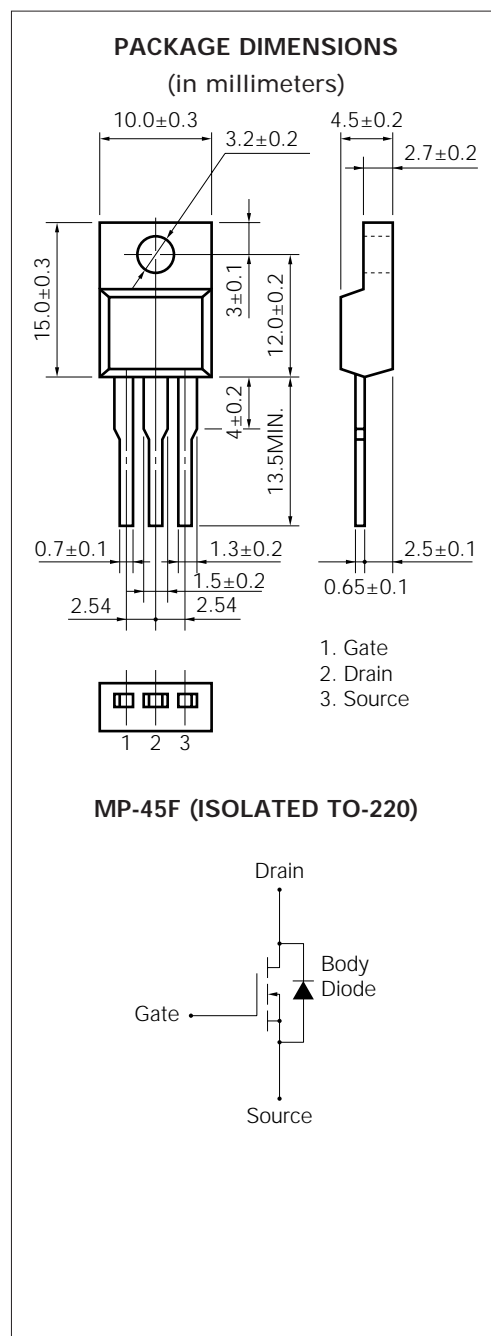

ELECTRICAL CHARACTERISTICS (T_A = 25 °C)

CHARACTERISTIC	SYMBOL	MIN.	TYP.	MAX.	UNIT	TEST CONDITIONS
Drain to Source On-State Resistance	R _{DS(on)}		1.7	2.4	Ω	V _{GS} = 10 V, I _D = 2.0 A
Gate to Source Cutoff Voltage	V _{GS(off)}	2.5		3.5	V	V _{DS} = 10 V, I _D = 1 mA
Forward Transfer Admittance	y _{fs}	1.0			S	V _{DS} = 10 V, I _D = 2.0 A
Drain Leakage Current	I _{DSS}			100	μA	V _{DS} = V _{DSS} , V _{GS} = 0
Gate to Source Leakage Current	I _{GSS}			±100	nA	V _{GS} = ±30 V, V _{DS} = 0
Input Capacitance	C _{iss}		550		pF	V _{DS} = 10 V
Output Capacitance	C _{oss}		130		pF	V _{GS} = 0
Reverse Transfer Capacitance	C _{rss}		25		pF	f = 1 MHz
Turn-On Delay Time	t _{d(on)}		11		ns	I _D = 2.0 A
Rise Time	t _r		6		ns	V _{GS(on)} = 10 V
Turn-Off Delay Time	t _{d(off)}		45		ns	V _{DD} = 150 V
Fall Time	t _f		7		ns	R _G = 10 Ω R _L = 75 Ω
Total Gate Charge	Q _G		20		nC	I _D = 4.0 A
Gate to Source Charge	Q _{GS}		4		nC	V _{DD} = 480 V
Gate to Drain Charge	Q _{GD}		10		nC	V _{GS} = 10 V
Body Diode Forward Voltage	V _{F(S-D)}		1.0		V	I _F = 4.0 A, V _{GS} = 0
Reverse Recovery Time	t _{rr}		320		ns	I _F = 4.0 A, V _{GS} = 0
Reverse Recovery Charge	Q _{rr}		1.2		μC	di/dt = 50 A/μs

Test Circuit 1 Avalanche Capability

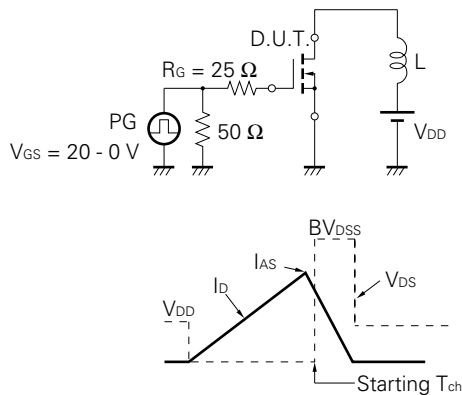

Test Circuit 2 Switching Time

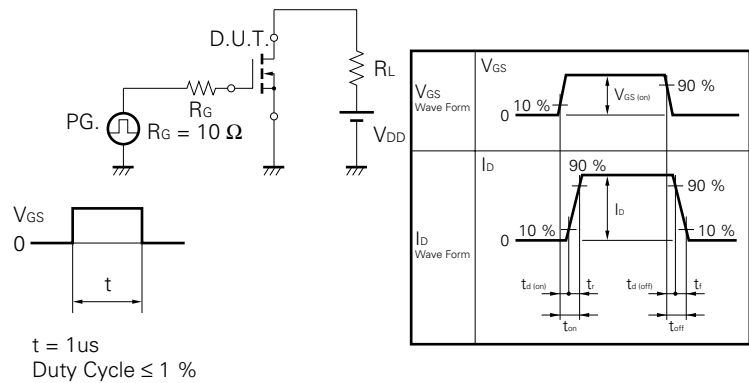

Test Circuit 3 Gate Charge

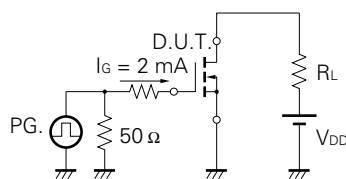

The application circuits and their parameters are for references only and are not intended for use in actual design-in's.

TYPICAL CHARACTERISTICS (T_A = 25 °C)

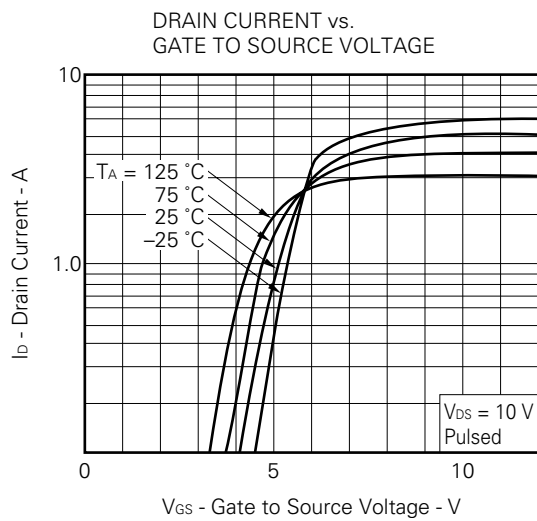
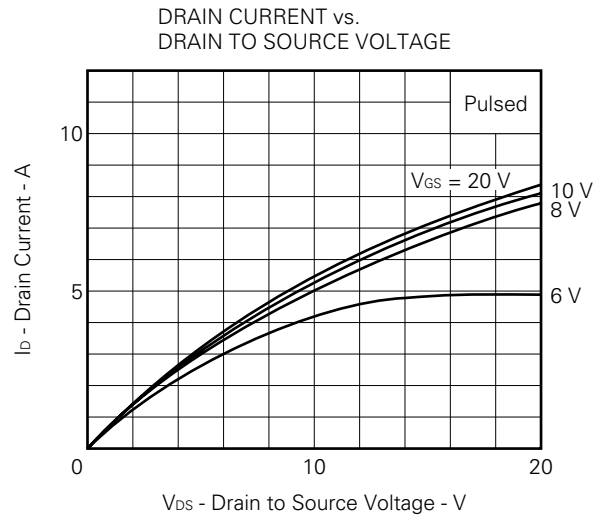
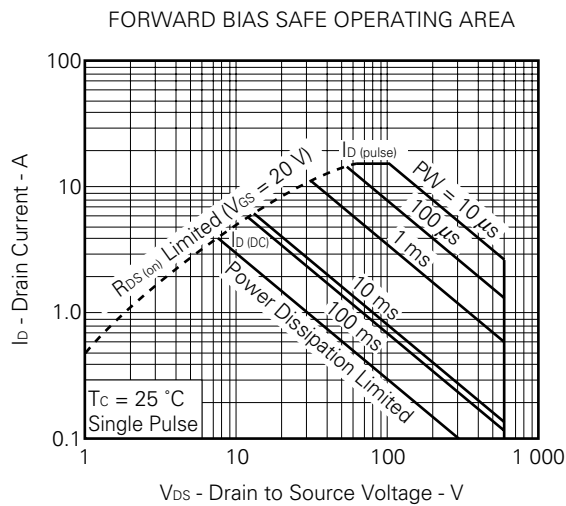
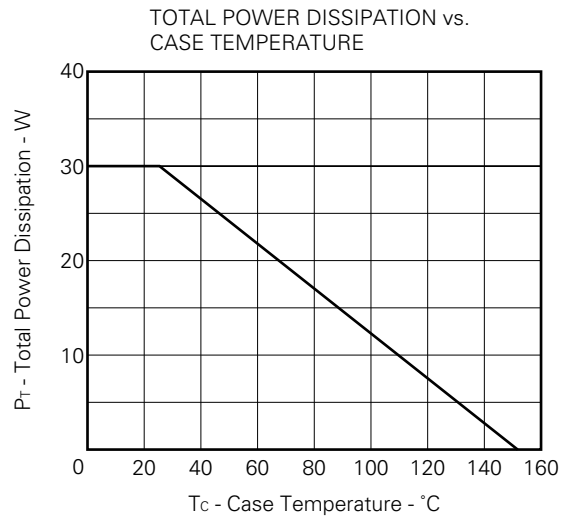
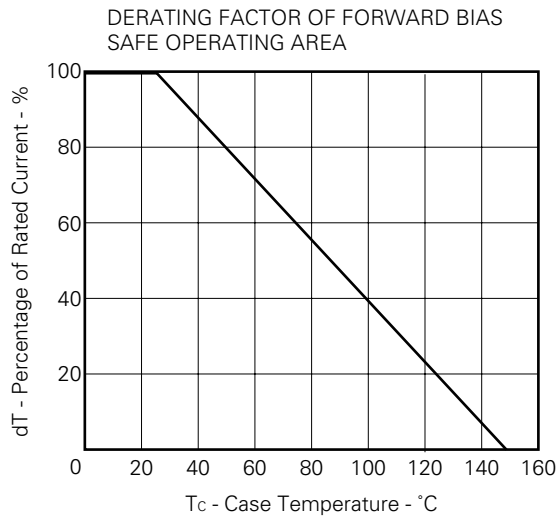

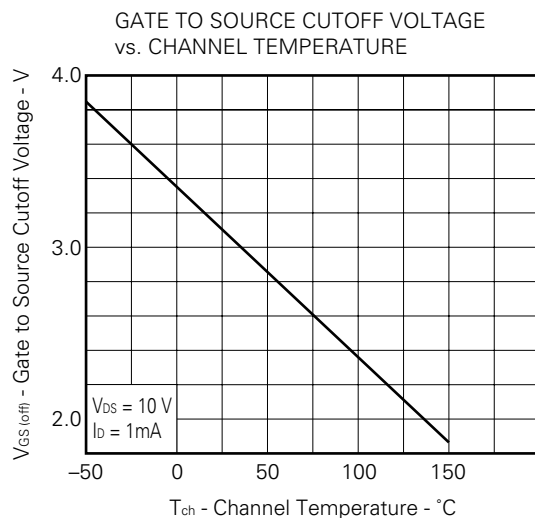
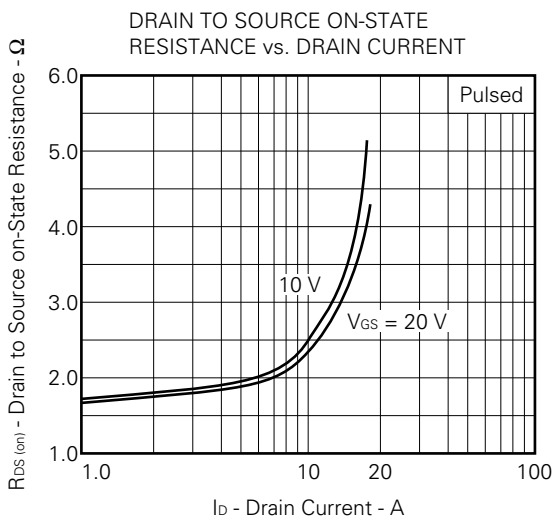
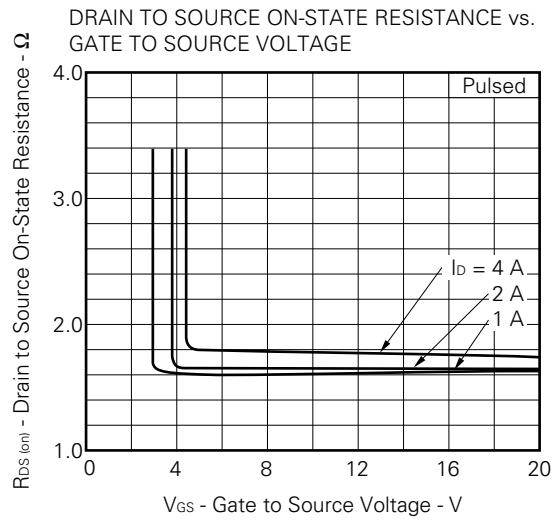
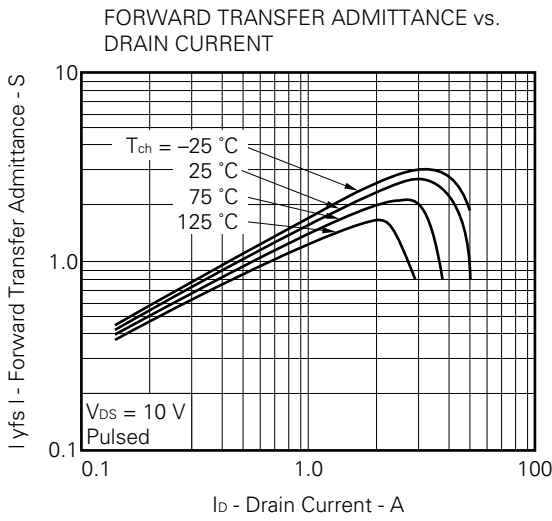
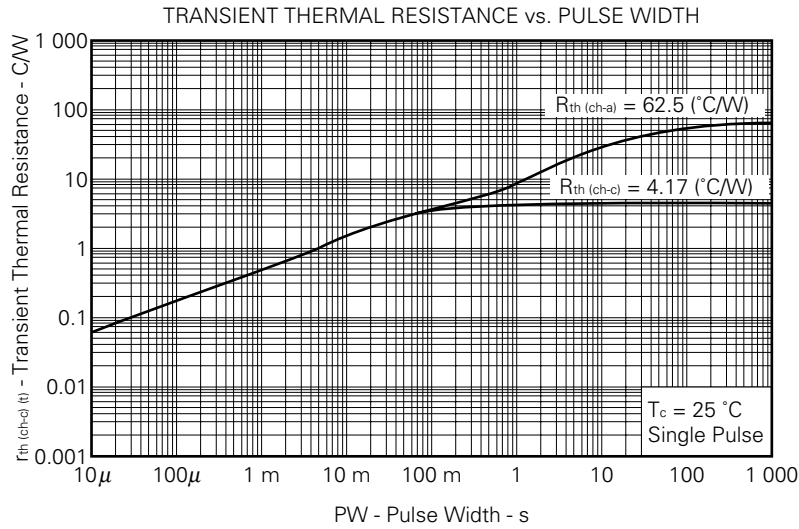

DRAIN TO SOURCE ON-STATE RESISTANCE vs. CHANNEL TEMPERATURE

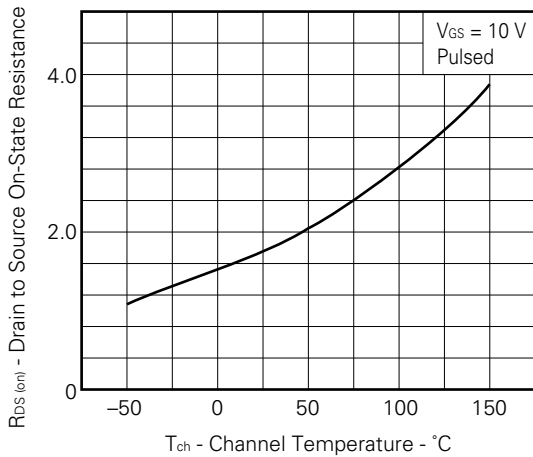

SOURCE TO DRAIN DIODE FORWARD VOLTAGE

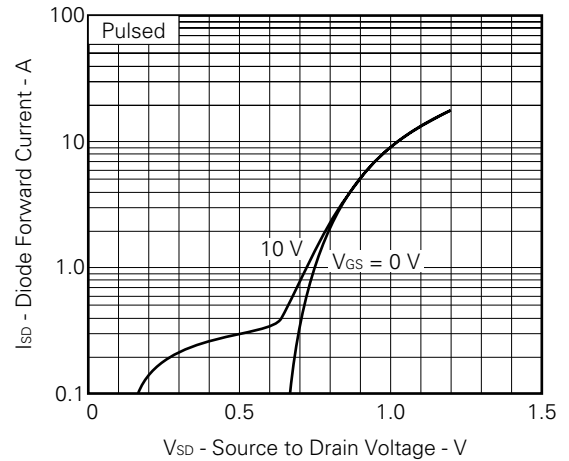

CAPACITANCE vs. DRAIN TO SOURCE VOLTAGE

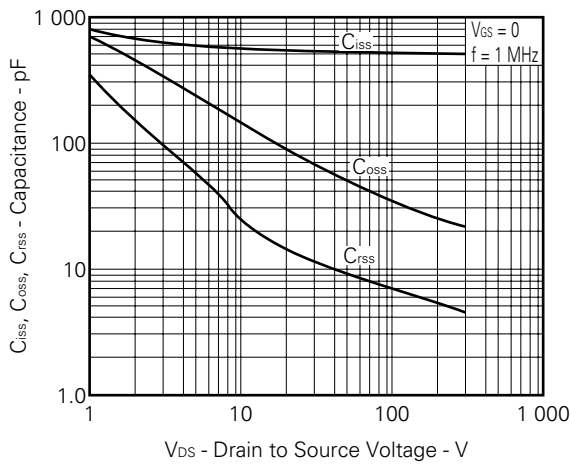

SWITCHING CHARACTERISTICS

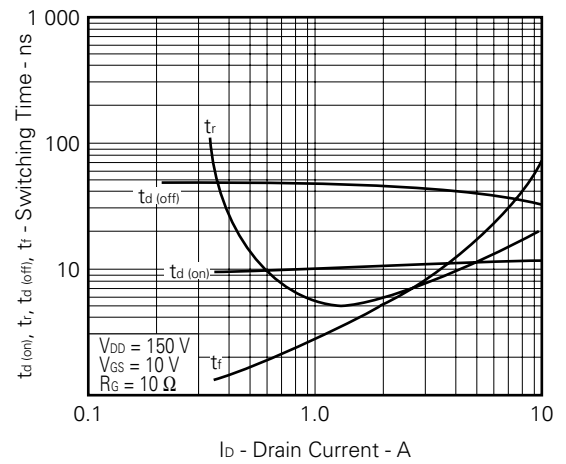

DYNAMIC INPUT CHARACTERISTICS

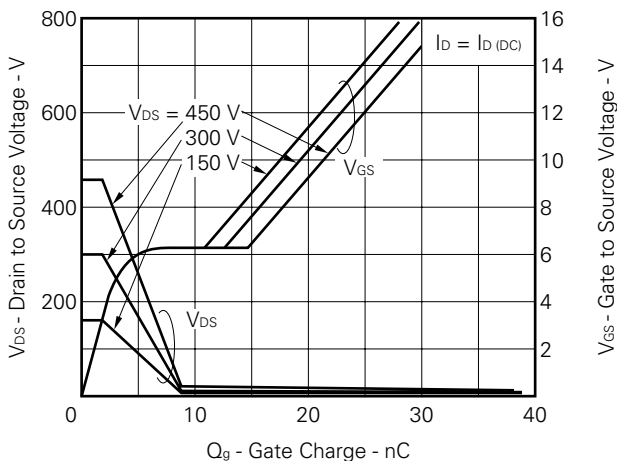

REVERSE RECOVERY TIME vs. DRAIN CURRENT

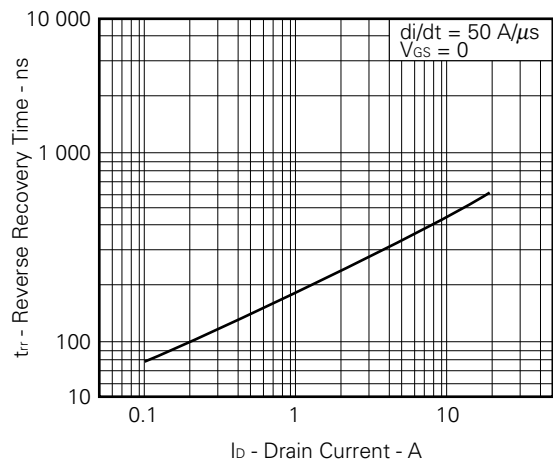

SINGLE AVALANCHE CURRENT vs. INDUCTIVE LOAD

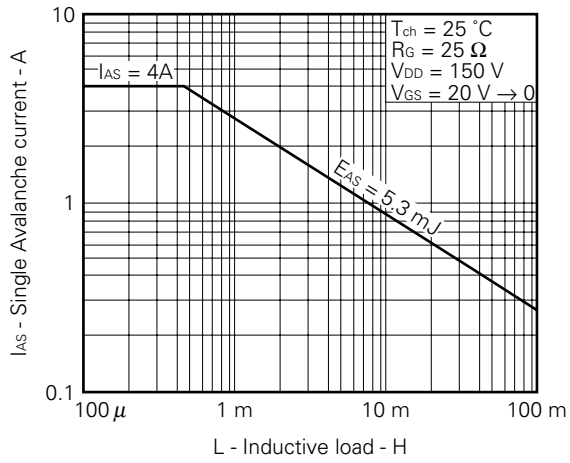

SINGLE AVALANCHE ENERGY vs. STARTING CHANNEL TEMPERATURE

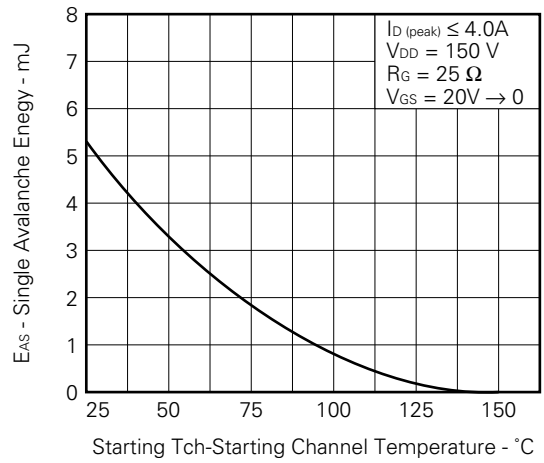

REFERENCE

Document Name	Document No.
NEC semiconductor device reliability/quality control system.	TEI-1202
Quality grade on NEC semiconductor devices.	IEI-1209
Semiconductor device mounting technology manual.	IEI-1207
Semiconductor device package manual.	IEI-1213
Guide to quality assurance for semiconductor devices.	MEI-1202
Semiconductor selection guide.	MF-1134
Power MOS FET features and application switching power supply.	TEA-1034
Application circuits using Power MOS FET.	TEA-1035
Safe operating area of Power MOS FET.	TEA-1037

The diode connected between the gate and source of the transistor serves as a protector against ESD. When this device is actually used, an additional protection circuit is externally required if a voltage exceeding the rated voltage may be applied to this device.

[MEMO]

No part of this document may be copied or reproduced in any form or by any means without the prior written consent of NEC Corporation. NEC Corporation assumes no responsibility for any errors which may appear in this document.

NEC Corporation does not assume any liability for infringement of patents, copyrights or other intellectual property rights of third parties by or arising from use of a device described herein or any other liability arising from use of such device. No license, either express, implied or otherwise, is granted under any patents, copyrights or other intellectual property rights of NEC Corporation or others.

While NEC Corporation has been making continuous effort to enhance the reliability of its semiconductor devices, the possibility of defects cannot be eliminated entirely. To minimize risks of damage or injury to persons or property arising from a defect in an NEC semiconductor device, customer must incorporate sufficient safety measures in its design, such as redundancy, fire-containment, and anti-failure features.

NEC devices are classified into the following three quality grades:

“Standard”, “Special”, and “Specific”. The Specific quality grade applies only to devices developed based on a customer designated “quality assurance program” for a specific application. The recommended applications of a device depend on its quality grade, as indicated below. Customers must check the quality grade of each device before using it in a particular application.

Standard : Computers, office equipment, communications equipment, test and measurement equipment, audio and visual equipment, home electronic appliances, machine tools, personal electronic equipment and industrial robots

Special : Transportation equipment (automobiles, trains, ships, etc.), traffic control systems, anti-disaster systems, anti-crime systems, safety equipment and medical equipment (not specifically designed for life support)

Specific : Aircrafts, aerospace equipment, submersible repeaters, nuclear reactor control systems, life support systems or medical equipment for life support, etc.

The quality grade of NEC devices in “Standard” unless otherwise specified in NEC's Data Sheets or Data Books. If customers intend to use NEC devices for applications other than those specified for Standard quality grade, they should contact NEC Sales Representative in advance.

Anti-radioactive design is not implemented in this product.